

Operating Manual for Models :

Model 4015 / 5015

Dual Channel
Universal Process Indicator



Safety

This equipment is supplied by a mains voltage which can cause an electric shock injury. Before removing the circuit board from its housing, switch the instrument off, isolate it from the mains power supply and make sure that it cannot be connected inadvertently by other persons.

If the circuit board is removed from its housing, do not apply power to the instrument unless specifically instructed to do so in these instructions. When working on live equipment, exercise great care, use insulated tools and test equipment, and do not work alone.

When fitting option boards, always put the circuit boards back in the housing with the back-plate securely fastened before powering up the instrument.

When handling circuit boards, ensure that full anti-static precautions are observed.

Replace external mains fuse with one of an equivalent type.

Cleaning

Do not clean the instrument while the instrument is on. Harsh abrasives, solvents, scouring cleaners and alkaline cleaning solutions, such as washing soda, should not be used especially on the display window. The outside of the instrument may be wiped down with a slightly damp clean cloth (lightly moistened with water only). Under no circumstances should you attempt to wipe the inside of the instrument.

Contents

Introduction	Page 3
Electrical specifications	Page 3
Input ranges	Page 3
Sensor excitation.....	Page 3
Power supply	Page 4
Programmable specifications	Page 4
Other specifications	Page 4
Installation (panel cutout)	Page 5
Installation (fastening)	Page 5
Display & keypad (during normal display mode)	Page 5
Display & keypad (during programming mode)	Page 5
Connections & links	Page 6
Hardware link selection for J4	Page 6
Power supply links	Page 6
Programming chart	Page 7
Programming chart continued.....	Page 8
Display codes explained	Page 9
Programming example	Page 10
Asciibus protocol	Page 11
Option 3000, 3001-P / M, 3002, 3003, 3004-P / M	Page 12
Option 3006, 3007, 3008, 3009, 3010, 3012, 3013	Page 13
Option 3014, 3017-P / M, 3018-P.....	Page 14
Option 3018-M, 3025, 3026	Page 15
Diagram "P"	Page 16
Diagram "M"	Page 16
Declaration of conformity	Page 16
Guarantee	Page 16

Introduction

The Model 4015, 5015 are Dual Channel Process Indicators which can be applied to many applications which require a dual input and a single display eg. Temperature and humidity monitoring. Each channel is individually setup for zero, span, input type and more. The unit boasts a number of useful mathematical functions such as addition, subtraction, multiplication and division of the two input channels. The display as well as alarms, analogue out, peak hold can be selected using channel A, Channel B or the above mentioned mathematical functions.

Options include linearisation, analog output and set-points up to a total of four. Excitation is standard and is link selectable for 2-wire / 3-wire transmitters and a potentiometer input.

Selected options now feature 'Plug & Play' technology, allowing option boards to be ordered separately & field fitted when required.

Model 4015 is a 4 digit (-1999 to 9999) indicator while the 5015 is a 5½ digit (-199999 to 199999) indicator.

Electrical Specifications

Accuracy & linearity	: 0.05% of F.S., or 1 count
Internal resolution	: 20000 counts (bi-polar)
Temperature coefficient	: 20 ppm / °C typical
Settling time for process inputs	: 0.5 seconds
Settling time for frequency input	: 5 milliseconds (with no filter)
Operating temperature range	: -10 to +50°C
Storage temperature range	: -40 to +80°C
Humidity	: < 85% non-condensing
Warm-up time	: None required

Electro-mechanical relays	: 250V AC, 30V DC, 2A, PF=1
Solid state relays	: 400 V AC/DC, 0.5A, PF=1
Analogue output accuracy	: 0.1% of full scale, 12 bits
Current analogue output load	: 500 W maximum
Voltage analogue output load	: 1 kW minimum
Memory retention	: Full non-volatile operation
Option 3006 isolation rating	: 1500 V
Declaration of conformity	: See last page

Input Ranges

0 - 20 mA, 4 - 20 mA, 0 - 200mV, 0 - 2 V, 0 - 10 V

Sensor Excitation

24V DC:	(17-26V), current limited. For 2-wire transmitters, proximity switches or encoders. With option 3010, current capability increases to 100mA
5V DC:	± 1%, maximum 25mA
2.5V DC:	Precision reference, 2mA max for pot (2 kW min)

Power Supply

Standard

115 / 230 VAC \pm 10%, link selectable, 50/60Hz, 5VA typ

Optional

8-30VDC isolated power supply (Option 3008), 5VA typ
 10-30VDC non-isolated power supply (Option 3028), 5VA typ
 95V-265V AC/DC isolated power supply (Option 3010), 5VA typ

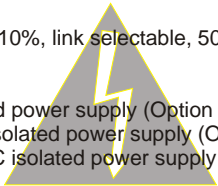

Programmable Specifications

4 Digit Models

Zero & full scale setting : -1999 to 9999
 Decimal point : Adjustable on all digits

Options :

Analog output zero & span : -1999 to 9999
 Alarm setpoint values : -1999 to 9999
 Alarm hysteresis : 0 to 255 (default 1)
 Alarm delay : 0 to 255 seconds (default 0)
 Alarm relay settings : Selectable HIGH or LOW alarm
 Alarm relay state : Selectable NO or NC
 Unit address : 0 to 99
 Baud rate : 2400, 4800, 9600, 19200

Other Specifications

DIN 48 x 96 housing, 147mm depth
 Industrial strength single piece housing

Housing is flame retardant ABS plastic that meets UL94 V-0
 Circuit board is flame retardant material that meets UL94 V-0

Front facia rating : IP65 (with o-ring seal supplied as standard)

5½ Digit Models

Zero & full scale setting : -199999 to 199999
 Decimal point : Adjustable on all digits
 Process filtering : 0.0 to 10.0 seconds

Options :

Analog output zero & span : -199999 to 199999
 Alarm setpoint values : -199999 to 199999
 Alarm hysteresis : 0 to 255 (default 1)
 Alarm delay : 0 to 255 seconds (default 0)
 Alarm relay settings : Selectable HIGH or LOW alarm
 Alarm relay state : Selectable NO or NC
 Unit address : 0 to 99
 Baud rate : 2400, 4800, 9600, 19200

Installation

Panel Cutout

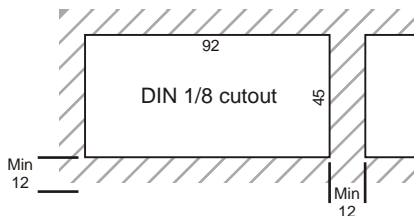

Installation

Fastening

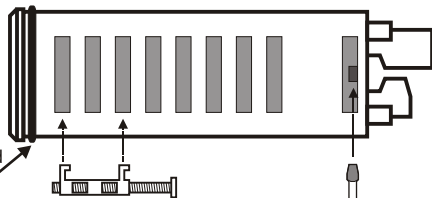

O-ring sealing gasket supplied as standard

The supplied fastening clips may be fitted on **the side** or the **top / bottom** of the housing. Ensure that the clip & screw is mounted as shown here.

Caution : Do not overtighten the screws.

To gain access to the circuit boards, switch power off and remove terminals from the back of the housing. Observe safety precautions. Use a screwdriver to clip the back-plate off.

During normal display mode

Display & Keypad

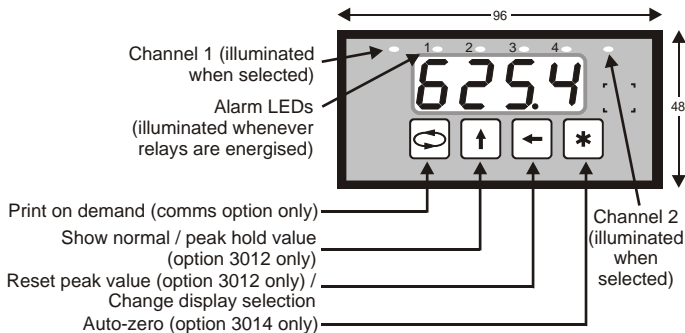

During programming mode

Display & Keypad

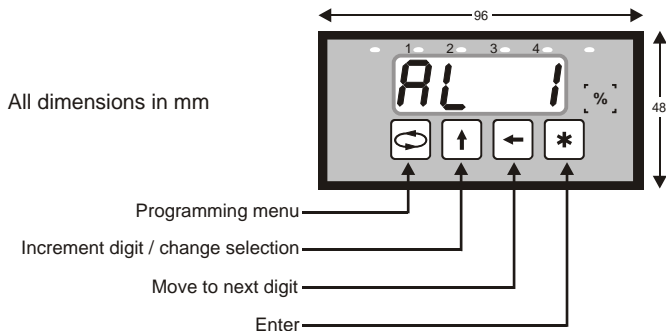

Connections & Links

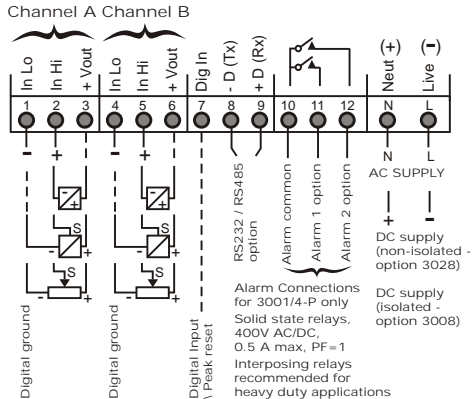

Power Supply Links

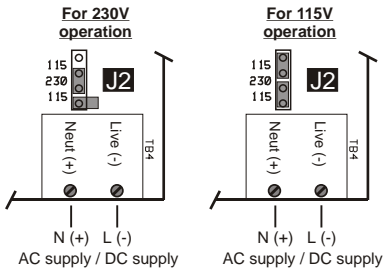

J2 link positions do
not matter for Option 3008,
Option 3028 or Option 3010.

**External 0.5A fuse
recommended**

Hardware Link Selection For J4

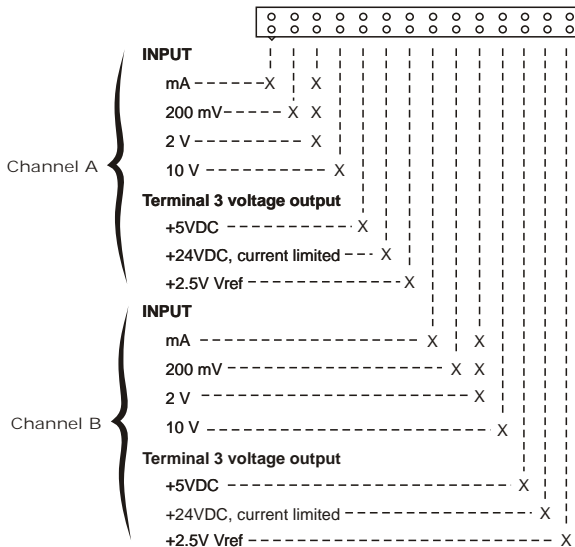

Place hardware links as shown in the diagrams.

Remember : Configuring this instrument requires two steps. (1) Select the correct hardware links as shown. (2) Program the instrument with the programming chart on page 7 & 8.

Programming Chart

READ ME FIRST !

- Note 1 : This programming chart is a simplified flowchart for users that have previous experience with this instrument. A programming example is available in the next few pages to assist new users in understanding this programming chart.
- Note 2 : Because this instrument has many options, all possible option menus are shown. Options that are not ordered will not appear in the programming sequence.
- Note 3 : Configuring this instrument requires two steps. (A) Select the correct hardware links (page 6). (B) Program the instrument with this chart.
- Note 4 : To enter programming mode, press the menu key for a few seconds (unless the optional keypad lock has been set). Programming mode timeout

**START
HERE**

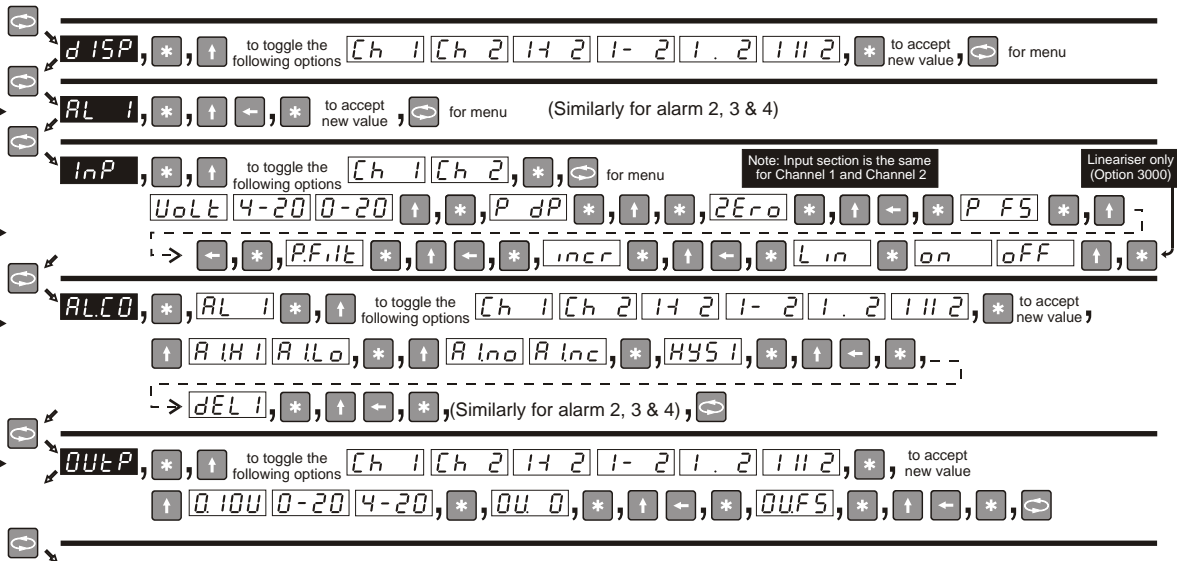

----- Continued on NEXT PAGE ----->

Programming Chart (cont.)

READ ME FIRST !

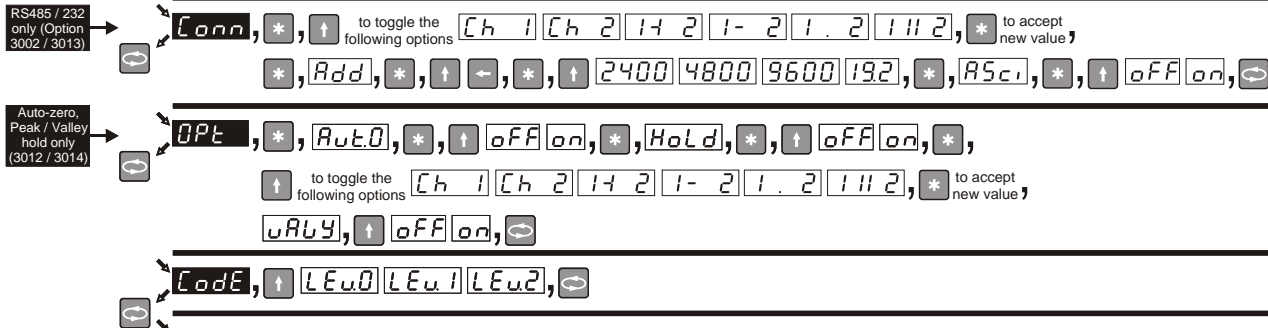

“END”. Instrument returns to normal display mode.

Display Codes Explained

d 15P Display value selection menu

[Ch 1] Channel 1

[Ch 2] Channel 2

[1+2] Channel 1 + Channel 2

[1-2] Channel 1 - Channel 2

[1.2] Channel 1 x Channel 2

[1/12] Channel 1 / Channel 2

InP Input selection menu

[Ch 1] Channel 1

[Ch 2] Channel 2

[4-20] [0-20] [Volt] Process input selection (4-20mA, 0-20mA, Volt)

[P dP] Process decimal point selection (non-floating point)

[2Err0] Process zero display configuration

[P FS] Process full scale display configuration

[P.Filt] Process filter - analog inputs (factor 0.0 to 9.9 secs)

[incr] Display increment. e.g. '10' would give dummy zero.

[Lin] Linearisation menu (on/off) select (optional)

[AL 1] [AL 2] [AL 3] [AL 4] 1st, 2nd, 3rd, 4th setpoint value

Alarm configuration menu (shown for 1st alarm only)

[RtH] [RtLo] 1st alarm setpoint select HIGH / LOW alarm

[RtNo] [Rtnc] 1st alarm setpoint normally OPEN / CLOSED contact

[HYS 1] 1st alarm setpoint hysteresis

[dEL 1] 1st alarm setpoint delay

OUTP Analogue output menu

[0 10V] [0-20] [4-20] Output selection (0-10V, 0-20mA, 4-20mA)

[0V 0] Output zero selection

[OUFS] Output full scale selection

OPt Option menu for Auto-zero feature and Peak / Valley Hold feature

[Aut0] [OFF] [on] Auto-zero option turned off or on

[Hold] [OFF] [on] Peak / valley hold option turned off or on

[uALY] [OFF] [on] Peak OR valley hold. "off" = peak. "on" = valley

Conn Communications menu (RS232 / RS485)

[Add] Unit address (default 0)

[2400] [4800] [9600] [192] Available baud rate values

[ASC,] [OFF] [on] Protocol selection. On = AsciiBus. Off = DigiBus.

Code Keypad lock security menu. See Option 3025 for more information.

[LEu0] [LEu1] [LEu2] Keypad lock security level. Level 0 = none, Level 1 = alarm value changes, Level 2 = full

[0000] [8888] Process overscale. Input has exceeded full scale value. / Display test mode.

[---] Hardware overrange. Reduce input signal to reduce saturation.

Please Note :

Display screens shown in black are to indicate the beginning of sub-menus.

Please Note :

PASS

If the front keypad has been locked, then the word "PASS" will appear. See option 3025 for more information.

Programming Example

Setting Up Alarm Values (Option)

Remember, the symbols on the keypad have the following definitions during programming.



Next Menu
Item



Increment digit



Next Digit



Enter /
Accept value



Press "Menu" for
3 seconds and continue
until AL 1 appears

AL 1



Press "Enter" to see
Alarm / Trip 1 value.

000000

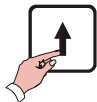

Press "Increment digit"
to increase value

000002



Press "Next digit" to
amend the next digit

000002.

Amend the other digits in the same way until the desired trip value is entered.



Press "Enter" to accept
Alarm 1 value.

AL 1



Press "Menu" to
proceed to next
trip value.

AL 2

Use the same menu steps above to change trip levels
for trip 2, 3 and 4.

The entire programming menu operates in a manner
similar to the example described above.

IGNORE THIS PAGE unless communications option has been ordered. When the RS232 (option 3013) or RS485 (option 3002) is ordered, two protocols are made available, namely ASCIIbus & DIGIbus protocols. DIGIbus is the default protocol which is used for the calibration and configuration of the instruments, and whenever the instrument is connected to master-slave systems. DIGIbus protocol is therefore used in complex bus systems, and is NOT described here. Please contact factory for the DIGIbus protocol.

ASCIIbus, which is described here, is much easier to use as it can easily interface to third party systems with very little engineering work required. It is a purely ASCII based (7 bit) protocol. The protocol is essentially designed for one way communications (instrument to PC). Under the "Conn" (connection) programming menu, ASCIIbus is enabled by selecting "ASCII" to "ON". If "OFF" is selected, the DIGIbus protocol will be active. Although designed for one way communications only, the ASCIIbus protocol contains an address. The address range is "00" to "99".

Using address "00" : If this address is selected, the instrument will only transmit data on demand by either momentarily pressing the 'menu' key, or by transmitting a byte (any ASCII character) to the DPM. This mode is useful for interfacing to printers. In addition, field ' A A ' will contain the ASCII character "blank/space". Field ' P ' will also contain the ASCII character "blank/space".

Using address "01" to "99". If any of these addresses are used, the meter continuously transmits information at approximately 5 times a second.

The data format string output from the indicator is (7 bit ASCII code is used):

Line Settings : 7 Data Bits, 1 Parity bit, Odd Parity, 1 Stop Bit.
 Baud Rate : Selectable 2400, 4800, 9600, 19200.
 Data Bits : Numerical ASCII characters : 0, 1, 2, 3, 4, 5, 6, 7, 8, 9
 Other ASCII characters : #, blank/space, +, -, CR, LF
 Protocol format is : # A A S D D D D D D D P CR LF
 where : # = indicates start of message
 : A A = Instrument address. ASCII 00 to 99. 00 is default.
 : S = sign (polarity) (ASCII "+" or "-").
 : D = data bits (data for 8 numerals). See Note (1).
 : P = decimal point position. ASCII 0 to 8.
 : CR = ASCII carriage return.
 : LF = ASCII line feed.

Note 1 : This protocol allows for future expansion. Therefore if Model 4015 is used for example, the first four digit data will contain the ASCII character "blank/space" and the last four digits will contain the display reading. Similarly, if the Model 5015 is used for example, the first 2 digit data will contain the ASCII character "blank/space" and the last six digits will contain the display reading.

Option 3000**Lineariser (Square Root / Cylinder / Sphere etc)**

If fitted, this option will accurately linearise signals for flow applications (square root extraction), s-curve (cylinder applications) and other non-linear signals. The type of linearisation required is specified at time of order and cannot be user selectable. However, the user has the option of toggling the lineariser feature 'ON' or 'OFF' in the channel ('ch 1' & 'ch 2') menu. See page 7 for programming

Option 3001-P**Two Set Point (Solid-State Relays)**

See page 7 for connection details. Wire for AL1 & AL2 only.

Option 3001-M**Two Set Point (Electro-Mechanical Relays)**

This option provides two alarm set points with electro-mechanical relays. This option board slots into the upper slot of the panel meter box. The upper terminals are clearly numbered 13-28 to differentiate them from the lower terminals. Both normally open and normally closed contacts are provided with each relay. The relays are rated at 250VAC / 30VDC @ 2A. Visual LED alarm indication is provided on the panel meter front. For connection wiring details, see diagram "M" on page 16. Connect wires for AL1 & AL2 only.

Option 3002**RS485 Serial Interface Option**

See page 7 for connection details. Select DIGIbus or ASCIIbus protocol from the program menu. See additional protocol documents.

Option 3003**0 - 20mA / 4 - 20mA Analogue Output Option**

See page 7 for connection details.

Option 3004-P**One Set Point (Solid-State Relay)**

This option is similar to Option 3001-P but with a single alarm only. See page 6 for connection details. Wire for AL1 only.

Option 3004-M**One Set Point (Electro-Mechanical Relay)**

This option is similar to Option 3001-M but with a one alarm set point only. See diagram "M" on page 16 for connections. Wire for AL1 only.

Option 3006**Isolated Options (Analogue Output / RS232 / RS485)**

This is ordered with option 3002, 3003, 3007 or 3013. It provides a minimum of 1500V isolation between input and output signal. Wiring connections are different for these isolated options. Use diagram "P" or diagram "M" on page 16 for wiring connections.

Option 3007**0 - 10V Analog Output Option**

See page 16 for connection details.

Option 3008**Galvanic Isolation (8V - 30VDC Supply) Option**

This power supply option provides 8V-30VDC supply isolation. See page 6 for connection details.

Option 3009**Parallel BCD Output Option**

This option is supplied as an additional slot in card in the top part of the instrument housing. See additional documentation.

Option 3010**95V-265V AC / DC Power Supply Option**

This options allows the instrument to operate from a wide range of AC & DC power supplies. The supply connections are on page 7.

Option 3012**Peak Or Valley (Max or Min) Hold Option**

This option displays and holds the max or min value (not both) of an input signal. This option is activated in the programming menu "Opt" by selecting whether "Hold" should be "On" or "Off", and selecting valley ("valy" = "On") or peak ("valy" = "Off") mode.

To show peak / normal value, press the "up" arrow for 3 seconds. To reset the peak / valley hold value, press the "star" key for 3 seconds, or use an external potential free contact (see page 6 for connection details). If analog output option is fitted, the output will hold as well. This option cannot be used with option 3014.

Option 3013**RS232 Serial Interface Option**

See the additional pages supplied for protocol details & page 6 for connection details. Ensure that maximum cable length from instrument to PC is less than 15 metres.

Option 3014**Auto-zero Option**

This option allows the operator to zero the display at any time and continue the measurement from that zero point. This option is activated "ON" or "OFF" in the "Opt" menu during programming (see page 7).

During normal operations, pressing the "star key" for 3 seconds will zero the display. The display can be zeroed at any time over and over again. If the analog output option is fitted, the output will follow the display.

Option 3017-P**Three Set Points (Solid-State Relays)**

This option provides three alarm set points with solid state relays. This option board slots into the upper slot of the panel meter box. The upper terminals are clearly numbered 13-28 to differentiate them from the lower terminals. Only normally open contacts are provided, which means that should the contacts be closed and the power fails, they will revert to a normally open condition. The relays are rated at 400V AC /DC @ 0.5A. Visual LED alarm indication is provided on the panel meter front. For connection wiring details, see diagram "P" on page 16. Connect wires for AL1, AL2 & AL3 only.

Option 3017-M**Three Set Points (Electro-Mechanical Relays)**

This option provides three alarm set points with electro-mechanical relays. This option board slots into the upper slot of the panel meter box. The upper terminals are clearly numbered 13-28 to differentiate them from the lower terminals. Both normally open and normally closed contacts are provided with each relay. The relays are rated at 250VAC / 30VDC @ 2A. Visual LED alarm indication is provided on the panel meter front. For connection wiring details, see diagram "M" on page 16. Connect wires for AL1, AL2 & AL3 only.

Option 3018-P**Four Set Points (Solid-State Relays)**

This option is similar to option 3017-P, but contains four relays (see option 3017-P). For connection wiring details, see diagram "P" on page 16. Connect wires for AL1, AL2, AL3 & AL4.

Option 3018-M**Four Set Points (Electro-Mechanical Relays)**

This option is similar to option 3017-M, but contains four relays (see option 3017-M). For connection wiring details, see diagram “M” on page 16. Connect wires for AL1, AL2, AL3 & AL4.

Option 3025**Keypad Lock Option**

The keypad lock option is used to prevent un-authorized access to the programming menu. When this option is ordered, a new sub-menu called “CODE” appears at the end of the programming sequence. See programming page 8. Three levels of keypad lockout are available: Level 0 - Full access to programming menu. Level 1 - User only has access to alarm set point values. Level 2 - Total programming menu lockout.

If this option is ordered, the factory default is “Lev 0”. If the keypad has been locked with either level 1 or 2, then the word “PASS” will appear on the display if the user attempts to enter programming mode. Pressing the menu key will return the instrument to normal display mode. However, if the user wishes to enter the programming menu, then when the word “PASS” appears, press in succession, 1 second apart, all four keys from right to left.



Declaration of Conformity

Diagram "P"



13 14 15 16 17 18 19 20 21 22 23 24 25 26 27 28



Upper Terminals
(Option boards)

1 2 3 4 5 6 7 8 9 10 11 12 N(+) L(-)



Lower Terminals
(Mother board)

Diagram "M"

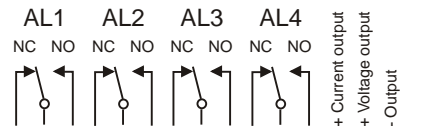

13 14 15 16 17 18 19 20 21 22 23 24 25 26 27 28



Upper Terminals
(Option boards)

1 2 3 4 5 6 7 8 9 10 11 12 N(+) L(-)



Lower Terminals
(Mother board)

Dual channel universal process indicator

Manufacturer : DPM / Calog / Instrotech

Type : 4015 / 5015
Options : 3000 to 3028

Corresponds to the requirements of the following EC directives:

EMC directive : 89/336/EEC
Low voltage directive : 73/23/EEC
The applicable harmonised standards are : EN 50081-1
: EN 50082-1
: EN 61010

Guarantee

This product is guaranteed against faulty workmanship or defective material, for a period of 2 (two) years from the date of delivery by INSTROTECH.

INSTROTECH undertakes to replace without charge all defective equipment which is returned during the period of guarantee (transportation costs prepaid) provided there is no evidence that the equipment has been abused or mishandled in any way.

In the interests of continuous product improvement, INSTROTECH reserves the right to alter any specification without prior notice.

 **INSTROTECH**

Instrotech Australia Pty Ltd
PO Box 3137
Newton SA 5073
www.instrotech.com.au
sales@instrotech.com.au
Tel (08) 8337 8033
Fax +61 8 8337 8656