

Operating Manual for Model :

Model 5002

Universal Programmable
Indicator for BCD,
Gray Code or
Binary Inputs



Safety

This equipment is supplied by a mains voltage which can cause an electric shock injury. Before removing the circuit board from its housing, switch the instrument off, isolate it from the mains power supply and make sure that it cannot be connected inadvertently by other persons.

If the circuit board is removed from its housing, do not apply power to the instrument unless specifically instructed to do so in these instructions. When working on live equipment, exercise great care, use insulated tools and test equipment, and do not work alone.

When fitting option boards, always put the circuit boards back in the housing with the back-plate securely fastened before powering up the instrument.

When handling circuit boards, ensure that full anti-static precautions are observed.

Replace mains fuse with one of an equivalent type or rating.

Cleaning

Do not clean the instrument while the instrument is on. Harsh abrasives, solvents, scouring cleaners and alkaline cleaning solutions, such as washing soda, should not be used especially on the display window. The outside of the instrument may be wiped down with a slightly damp clean cloth (lightly moistened with water only). Under no circumstances should you attempt to wipe the inside of the instrument.

Contents

Introduction	Page 3
Electrical specifications	Page 3
Power supply	Page 4
Programmable settings	Page 4
Other specifications	Page 4
Installation (panel cutout)	Page 5
Installation (fastening)	Page 5
Display & keypad (during normal display mode)	Page 5
Display & keypad (during programming mode)	Page 5
Terminations for Parallel BCD Input	Page 6
Terminations for Multiplexed BCD Input	Page 6
Terminations for Gray Code / Binary Input	Page 7
Power supply links	Page 7
Programming chart	Page 8
Display codes explained	Page 9
Programming example	Page 10
Asciibus communications	Page 11
Option 3001-P / M, 3002, 3003, 3004-P / M	Page 12
Option 3006, 3007, 3008, 3010, 3012	Page 13
Option 3013, 3017-P / M, 3018-P / M	Page 14
Option 3025	Page 15
Diagram "P"	Page 16
Diagram "M"	Page 16
Declaration of conformity	Page 16
Guarantee	Page 16

Introduction

The Model 5002 is a 6 digit (-199999 to 999999) red LED programmable indicator for parallel digital inputs, such as BCD, Gray Code & Binary inputs. As a universal indicator, the instrument is fully programmable from the front pushbuttons for decimal point selection, scaling, positive or negative logic, parallel or multiplexed BCD input, Gray Code input & Binary input. The panel mount housing is a standard DIN 48 x 96 size.

Applications include displays for PLC outputs for process control, & displays for absolute shaft encoders with parallel outputs.

Options include programmable analog output, one, two, three or four alarms, RS 232 output etc. The analog output is rangeable from the front pushbuttons.

The instrument meets European Community EMC directive 89/336/EEC & Low Voltage Directive 73/23/EEC.

Selected options now feature 'Plug & Play' technology, allowing option boards to be ordered separately & field fitted when required.

Note :

Due to the finite number of input pins at the back of the instrument, the following display limitations may apply:

Parallel BCD input : 5 $\frac{3}{4}$ digits only (-199999 to 799999)
 All other inputs : 6 digits (-199999 to 999999 i.e. no limitations)

Electrical Specifications

Input types	: BCD, Gray Code or Binary
Logic	: Positive or negative
Voltage level	: 5 to 24V
Internal pull-ups	: Yes
Display	: 6 digit, 14.2mm red LED
Display update rate	: 5 per second
Operating temp. range	: -10°C to +50°C
Storage temperature range	: -40 to +80°C
Humidity	: < 85% non-condensing
Warm up time	: None
Relays, electro-mechanical	: 250VAC, 30VDC, 2A, PF=1
Relays, solid state	: 400V AC/DC, 0.5A, PF=1
Analog output accuracy	: 0.1% of full scale
Temperature coefficient	: 20 ppm / °C typically
Current analog output load	: 500 Ω maximum
Voltage analog output load	: 1 k Ω minimum
Memory retention	: Full non-volatile operation
Option 3006 isolation rating	: 1500 V
Declaration of conformity	: See last page

Note : Relays & analog output are options

Power Supply

Standard

115 / 230 VAC \pm 10%, link selectable, 50/60Hz, 5VA typical
12VDC or 24VDC non-isolated on request, 5VA typical

Optional

12VDC isolated power supply option, 8VA typical (Option 3008-12)
24VDC isolated power supply option, 8VA typical (Option 3008-24)
95V-265V AC/DC power supply option, 8VA typical (Option 3010)

Other Specifications

DIN 48 x 96 housing, 147mm depth
Industrial strength single piece housing

Housing is flame retardant ABS plastic that meets UL94 V-0
Circuit board is flame retardant material that meets UL94 V-0

Front panel rating : IP65 (with o-ring seal supplied as standard)

Programmable Settings

Standard :

Input type : BCD, Gray Code or Binary (default)
Decimal point : Selectable on any digit (default is 00000.o)
Scaling : 000.001 to 999.999 (default = 1.000)
Logic : Positive (default) or negative
BCD type : Parallel (default) or multiplexed

Options :

Analog output zero & span : -199999 to 999999
Alarm setpoint values : -199999 to 999999 (default)
Alarm relay settings : Selectable HIGH (default) or LOW alarm
Alarm relay state : Selectable NO (default) or NC
Alarm hysteresis : 0 to 255 seconds (default is 1)
Alarm delay : 0 (default) to 255 seconds
Protocol options : DPM's DIGIbus (default) or ASCIIbus
RS485 address (Digibus) : 0 (default) to 127
RS485 address (Asciibus) : 0 (default) to 99
RS232 / RS485 baud rate : 2400, 4800, 9600 (default), 19200
Keypad lockout : Choice of 3 levels (see option 3025)
: Defaults to level 1 lockout

Installation

Panel Cutout

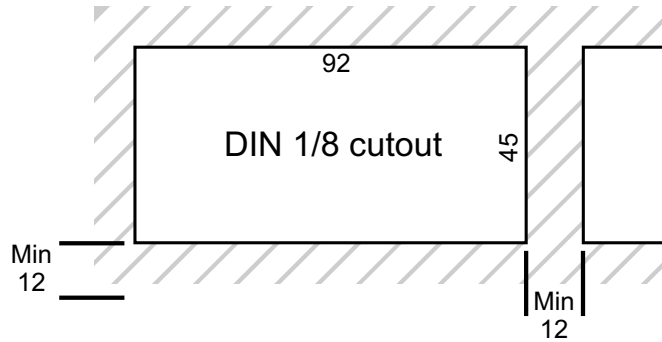

Installation

Fastening

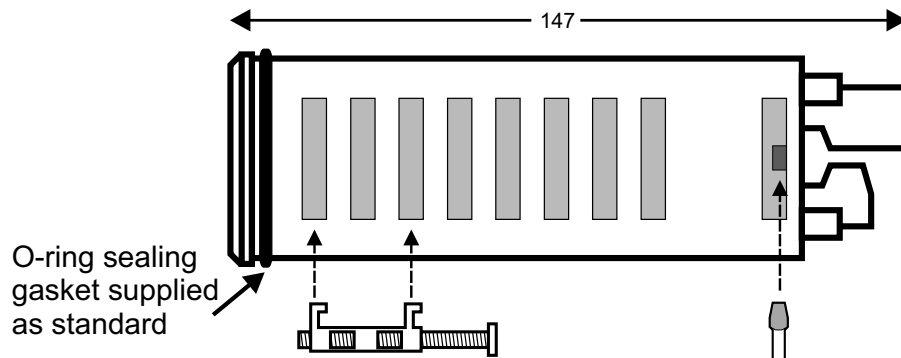

The supplied fastening clips may be fitted on **the side** or the **top / bottom** of the housing. Ensure that the clip & screw is mounted as shown here.

To gain access to the circuit boards, switch power off and remove terminals from the back of the housing. Observe safety precautions. Use a screwdriver to clip the back-plate off.

Caution : Do not overtighten the screws.

During normal display mode

Display & Keypad

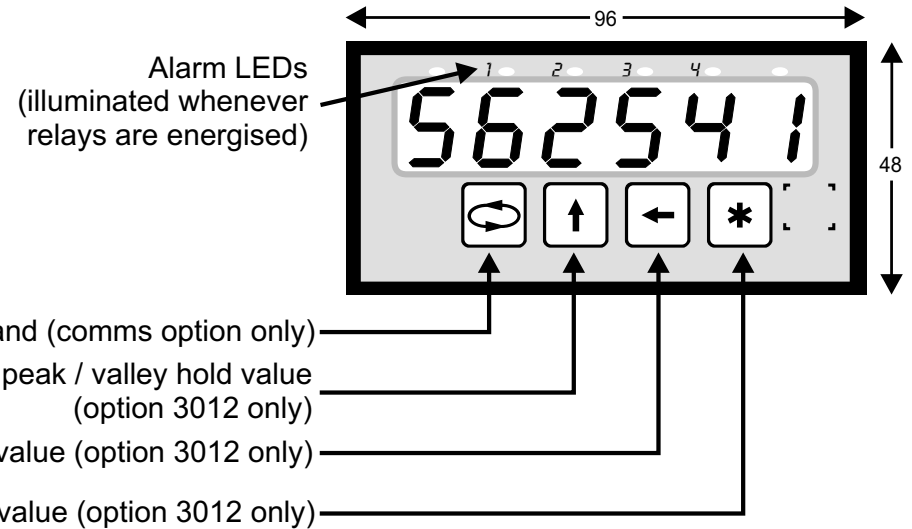

During programming mode

Display & Keypad

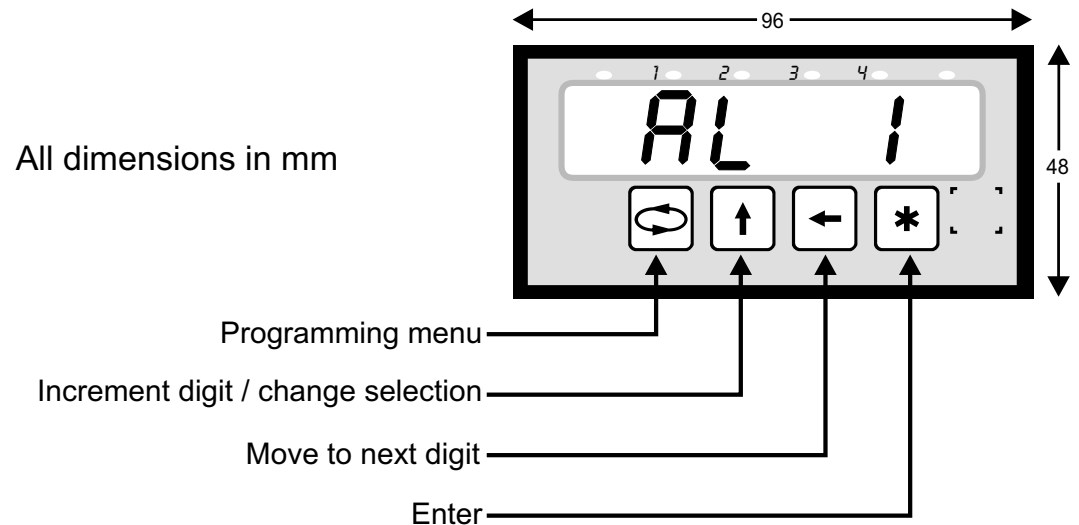

Terminations

Parallel BCD Input

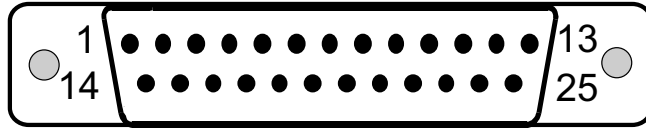
5 ³/₄ Digit Only (-199999 to 799999)

25-way D-type male connector
at the back of the indicator

1 = Binary 1 units	9 = Binary 1 ten thousands
14 = Binary 2 units	22 = Binary 2 ten thousands
2 = Binary 4 units	10 = Binary 4 ten thousands
15 = Binary 8 units	23 = Binary 8 ten thousands
3 = Binary 1 tens	11 = Binary 1 hundred thousands
16 = Binary 2 tens	24 = Binary 2 hundred thousands
4 = Binary 4 tens	12 = Binary 4 hundred thousands
17 = Binary 8 tens	25 = Common (negative)
5 = Binary 1 hundreds	13 = Polarity pin (Note 1)
18 = Binary 2 hundreds	
6 = Binary 4 hundreds	
19 = Binary 8 hundreds	
7 = Binary 1 thousands	
20 = Binary 2 thousands	
8 = Binary 4 thousands	
21 = Binary 8 thousands	

Note (1) : If Positive logic is selected in the menu, then a Low input to pin 13 implies negative polarity.
: If Negative logic is selected in the menu, then a Low input to pin 13 implies positive polarity.

Note : Illegal BCD input states are clamped to a value of "9".

Multiplexed BCD Input

Terminations

Full 6 Digit (-199999 to 999999)

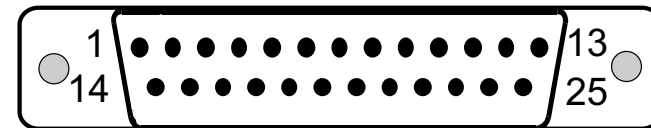

25-way D-type male connector
at the back of the indicator

1 = Binary 1
14 = Binary 2
2 = Binary 4
15 = Binary 8
3 = Latch enable, units
16 = Latch enable, tens
4 = Latch enable, hundreds
17 = Latch enable, thousands
5 = Latch enable, ten thousands
18 = Latch enable, hundred thousands
25 = Common (negative)
13 = Polarity pin (Note 1)
6, 7, 8, 9, 10, 11, 12, 19, 20, 21, 22, 23, 24 = Not used

Terminations

Gray Code / Binary Input

Full 6 Digit (-199999 to 999999)

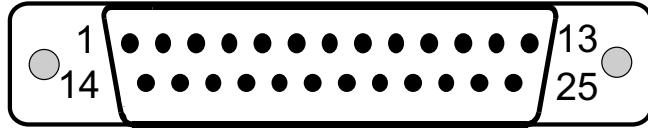

25-way D-type male connector
at the back of the indicator

- | | |
|-----------------|----------------------------|
| 1 = Bit 1 (LSB) | 9 = Bit 17 |
| 14 = Bit 2 | 22 = Bit 18 |
| 2 = Bit 3 | 10 = Bit 19 |
| 15 = Bit 4 | 23 = Bit 20 |
| 3 = Bit 5 | 11 = Not used |
| 16 = Bit 6 | 24 = Not used |
| 4 = Bit 7 | 12 = Not used |
| 17 = Bit 8 | 25 = Common (negative) |
| 5 = Bit 9 | 13 = Polarity pin (Note 1) |
| 18 = Bit 10 | |
| 6 = Bit 11 | |
| 19 = Bit 12 | |
| 7 = Bit 13 | |
| 20 = Bit 14 | |
| 8 = Bit 15 | |
| 21 = Bit 16 | |

Power Supply Links

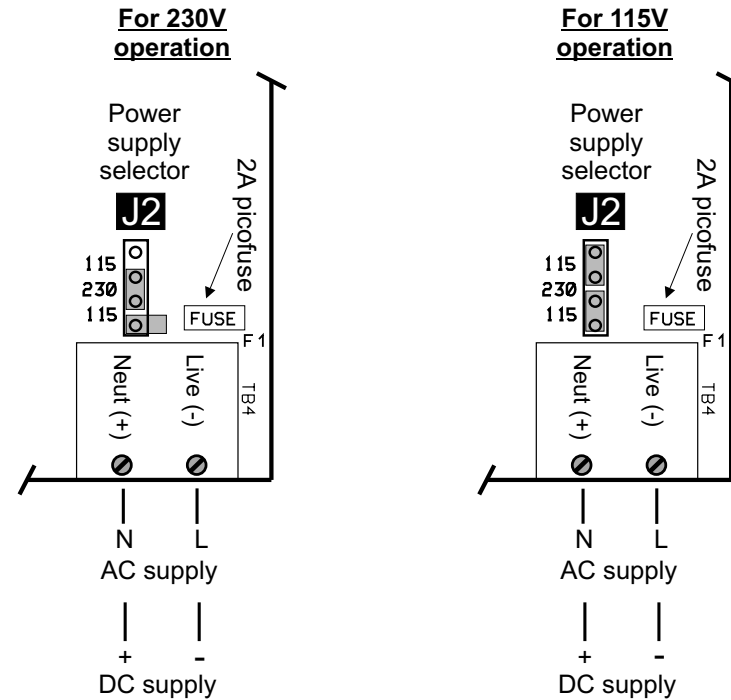

J2 link positions do not matter for DC supply
or for Option 3008 or Option 3010.

Note (1) : If Positive logic is selected in the menu, then a Low input to pin 13 implies negative polarity.
: If Negative logic is selected in the menu, then a Low input to pin 13 implies positive polarity.

Programming Chart

Note 1 : This programming chart is a simplified flowchart for users that have previous experience with this instrument. A programming example is available in the next few pages to assist new users in understanding this chart.

**START
HERE**

Note 2 : Because this instrument has many options, all possible option menus are shown. Options that are not ordered will not appear in the menu.

Note 3 : To enter programming mode, press the menu key for a few seconds (unless the optional keypad lock has been set). Programming mode timeout is about 20 seconds. If no key is pressed for 20 seconds during programming, the instrument returns to normal display mode.

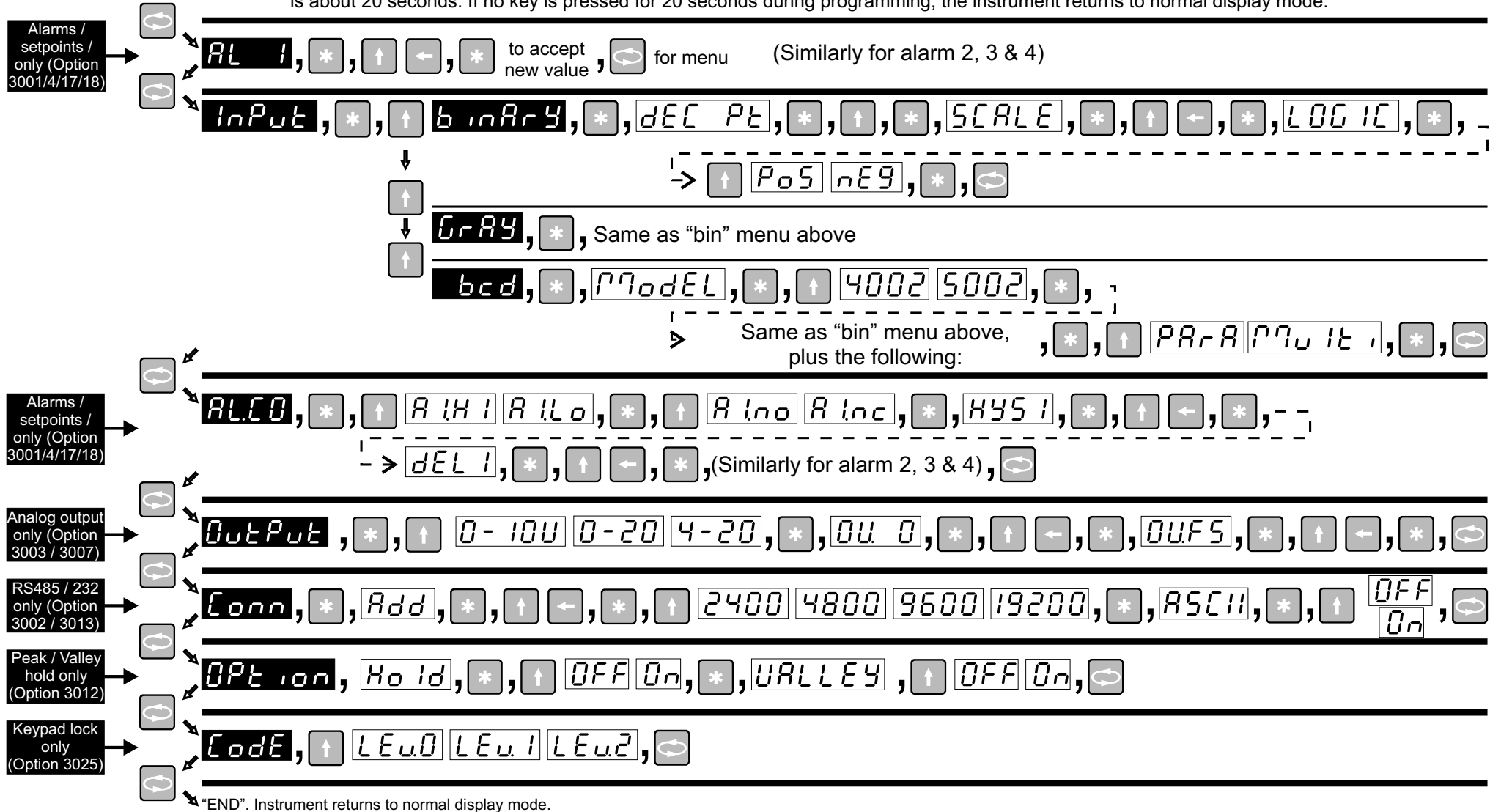

Display Codes Explained

AL 1 **AL 2** **AL 3** **AL 4** 1st, 2nd, 3rd, 4th setpoint value

ALCO Alarm configuration menu (shown for 1st alarm only)

ALHI **ALLO** 1st alarm setpoint select HIGH / LOW alarm

ALNO **ALNC** 1st alarm setpoint normally OPEN / CLOSED contact

HYS 1 1st alarm setpoint hysteresis

dEL 1 1st alarm setpoint delay

Output Analog output menu

0-10V **0-20** **4-20** Output selection (0-10V, 0-20mA, 4-20mA)

OU 0 Output zero selection

OUFS Output full scale selection

Comm Communications menu (RS232 / RS485)

ADD Unit address (default 0)

2400 **4800** **9600** **19200** Available baud rate values

ASCII **OFF** **On** Protocol selection. On = AsciiBus. Off = DigiBus.

Opt ion Option menu

Hold Peak / valley hold menu (min / max hold)

OFF **On** Turn the peak / valley hold feature on or off

VALLEY Peak / valley hold selector

OFF **On** If "off", peak hold mode. If "on", valley hold mode

Code Keypad lock. Select on or off. See Option 3025.

LEu0 **LEu1** **LEu2** Keypad lock security level. Level 0 = none, Level 1 = alarm value changes, Level 2 = full

Input Input selection menu

binary Binary input sub-menu

GRAY Gray Code input sub-menu

bcd BCD input sub-menu

DEC Pt Decimal point for display

SCALE Scaling factor (range of 0.001 to 999.999)

LOGIC **POS** **NEG** Logic selection, positive or negative (true or inverse)

Model Model selection menu (this is to provide pin for pin compatibility for previous models).

5002 Default setting. The instrument is normally used as a Model 5002, which this manual describes.

4002 If pin compatibility is required with the old Model 4002, then select this mode (use 4002 wiring sheet).

PARA **Pin It** For BCD input, select whether parallel or multiplexed input

000000 Display overrange

uuuuuu Display underrange

888888 Display test mode / power up mode

Please Note :

PASS

If the front keypad has been locked, then the word "PASS" will appear. See option 3025 for more information.











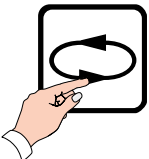

Please Note :

Display screens shown in black are to indicate the beginning of sub-menus.

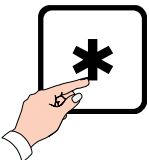

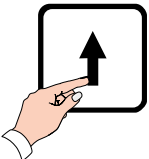

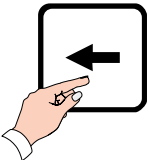
Programming Example

Setting Up Alarm Values (Option)

Remember, the symbols on the keypad have the following definitions during programming.

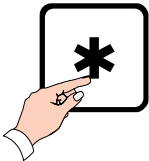
			
Next Menu Item	Increment digit	Next Digit	Enter / Accept value
	Press "Menu" for 3 seconds		
	Press "Enter" to see Alarm / Trip 1 value.		
	Press "Increment digit" to increase value		
	Press "Next digit" to amend the next digit		

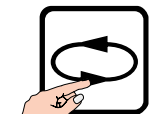
Amend the other digits in the same way until the desired trip value is entered.

	Press "Enter" to accept Alarm 1 value.	
	Press "Menu" to proceed to next trip value.	

Use the same menu steps above to change trip levels for trip 2, 3 and 4.

The entire programming menu operates in a manner similar to the example described above.

IGNORE THIS PAGE unless communications option has been ordered. When the RS232 (option 3013) or RS485 (option 3002) is ordered, two protocols are made available, namely ASCIIbus & DIGIbus protocols. DIGIbus is the default protocol which is used for the calibration and configuration of the instruments, and whenever the instrument is connected to master-slave systems. DIGIbus protocol is therefore used in complex bus systems, and is NOT described here. Please contact factory for the DIGIbus protocol.

ASCIIbus, which is described here, is much easier to use as it can easily interface to third party systems with very little engineering work required. It is a purely ASCII based (7 bit) protocol. The protocol is essentially designed for one way communications (instrument to PC). Under the "Conn" (connection) programming menu, ASCIIbus is enabled by selecting "ASCI" to "ON". If "OFF" is selected, the DIGIbus protocol will be active. Although designed for one way communications only, the ASCIIbus protocol contains an address. The address range is "00" to "99".

Using address "00" : If this address is selected, the instrument will only transmit data on demand by either momentarily pressing the 'menu' key, or by transmitting a byte (any ASCII character) to the DPM. This mode is useful for interfacing to printers. In addition, field ' A A ' will contain the ASCII character "blank/space". Field ' P ' will also contain the ASCII character "blank/space".

Using address "01" to "99". If any of these addresses are used, the meter continuously transmits information at approximately 5 times a second.

The data format string output from the indicator is (7 bit ASCII code is used):

Line Settings : 7 Data Bits, 1 Parity bit, Odd Parity, 1 Stop Bit.
 Baud Rate : Selectable 2400, 4800, 9600, 19200.
 Data Bits : Numerical ASCII characters : 0, 1, 2, 3, 4, 5, 6, 7, 8, 9
 Other ASCII characters : #, blank/space, +, -, CR, LF
 Protocol format is : # A A S D D D D D D D P CR LF
 where : # = indicates start of message
 : A A = Instrument address. ASCII 00 to 99. 00 is default.
 : S = sign (polarity) (ASCII "+" or "-").
 : D = data bits (data for 8 numerals). See Note (1).
 : P = decimal point position. ASCII 0 to 8.
 : CR = ASCII carriage return.
 : LF = ASCII line feed.

The output will follow the display reading. This means that if the peak-hold option has been ordered and activated, the communications output will peak-hold as well.

Note 1 : This protocol allows for future expansion. Therefore if Model 4001 is used for example, the first four digit data will contain the ASCII character "blank/space" and the last four digits will contain the display reading. Similarly, if the Model 5001 is used for example, the first 2 digit data will contain the ASCII character "blank/space" and the last six digits will contain the display reading.

Option 3001-P**Two Setpoint Alarms (Solid State Relays)**

This option provides two alarm setpoints with solid state relays. This option board slots into the upper slot of the panel meter box. The upper terminals are clearly numbered 13-28 to differentiate them from the lower terminals. Only normally open contacts are provided, which means that should the contacts be closed and the power fails, they will revert to a normally open condition. The relays are rated at 400V AC /DC @ 0.5A. Visual LED alarm indication is provided on the panel meter front. For connection wiring details, see diagram "P" on page 16. Connect wires for AL1 & AL2 only.

Option 3001-M**Two Setpoint Alarms (Electro-Mechanical Relays)**

This option provides two alarm setpoints with electro-mechanical relays. This option board slots into the upper slot of the panel meter box. The upper terminals are clearly numbered 13-28 to differentiate them from the lower terminals. Both normally open and normally closed contacts are provided with each relay. The relays are rated at 250VAC / 30VDC @ 2A. Visual LED alarm indication is provided on the panel meter front. For connection wiring details, see diagram "M" on page 16. Connect wires for AL1 & AL2 only.

Option 3002**RS485 Communications Option**

See diagram "M" or "P" on page 16 for connection details. Select DIGIbus or ASCIIbus protocol from the program menu.

Option 3003**0 - 20mA / 4 - 20mA Analog Output Option**

This option is provided on an option board that slots into the upper slot of the panel meter box. The upper terminals are clearly numbered 13-28 to differentiate them from the lower terminals. See diagram "M" or "P" on page 16 for wiring details.

Option 3004-P**One Setpoint Alarm (Solid State Relay)**

This option is similar to Option 3001-P but with a one alarm setpoint only. See diagram "P" on page 16 for connection details. Wire for AL1 only.

Option 3004-M**One Setpoint Alarm (Electro-Mechanical Relay)**

This option is similar to Option 3001-M but with a one alarm setpoint only. See diagram "M" on page 16 for connection details. Wire for AL1 only.

Option 3006

Isolated Options (Analog Output / RS232 / RS485)

This is ordered with option 3002, 3003, 3007 or 3013. It provides a minimum of 1500V isolation between input and output signal. Use diagram "P" or diagram "M" on page 16 for wiring connections.

Option 3007

0 - 10V Analog Output Option

This option is provided on an option board that slots into the upper slot of the panel meter box. The upper terminals are clearly numbered 13-28 to differentiate them from the lower terminals. See diagram "M" or "P" on page 16 for wiring details.

Option 3008

Galvanic Isolation (12V / 24V Supply) Option

This power supply option provides 12 or 24VDC supply isolation. See page 7 for connection details.

Option 3009

Parallel BCD Output Option

This option is supplied as an additional slot in card in the top part of the instrument housing. See additional documentation.

Option 3010

95V-265V AC / DC Power Supply Option

This options allows the instrument to operate from a wide range of AC and DC power supplies. See page 7 for supply connections.

Option 3012

Peak Or Valley (Max or Min) Hold Option

This option displays and holds the max or min value (not both) of an input signal. This option is activated in the programming menu "Option" by selecting whether "Hold" should be "On" or "Off", and selecting valley ("valley" = "On") or peak ("valley" = "Off") mode.

To show peak / valley value, press the "up" arrow for 3 seconds ("Hold" followed by "End" will appear on the display). To show normal display value, press the "side" arrow key for 3 seconds ("Pro" followed by "End" will appear on the display). To reset the peak / valley hold value, press the "star" key for 3 seconds ("reset" followed by "End" will appear on the display). If analog output option is fitted, the output will hold as well.

Option 3013

RS232 Communications Option

See diagram “M” or “P” on page 16 for connection details. Select DIGIbus or ASCIIbus protocol from the program menu. Ensure that maximum cable length from instrument to PC is less than 15 metres.

Option 3017-P

Three Alarm Setpoints (Solid State Relays)

This option provides three alarm setpoints with solid state relays. This option board slots into the upper slot of the panel meter box. The upper terminals are clearly numbered 13-28 to differentiate them from the lower terminals. Only normally open contacts are provided, which means that should the contacts be closed and the power fails, they will revert to a normally open condition. The relays are rated at 400V AC /DC @ 0.5A. Visual LED alarm indication is provided on the panel meter front. For connection wiring details, see diagram “P” on page 16. Connect wires for AL1, AL2 & AL3 only.

Option 3017-M

Three Alarm Setpoints (Electro-Mechanical Relays)

This option provides three alarm setpoints with electro-mechanical relays. This option board slots into the upper slot of the panel meter box. The upper terminals are clearly numbered 13-28 to differentiate them from the lower terminals. Both normally open and normally closed contacts are provided with each relay. The relays are rated at 250VAC / 30VDC @ 2A. Visual LED alarm indication is provided on the panel meter front. For connection wiring details, see diagram “M” on page 16. Connect wires for AL1, AL2 & AL3 only.

Option 3018-P

Four Alarm Setpoints (Solid State Relays)

This option is similar to option 3017-P, but contains four relays (see option 3017-P). For connection wiring details, see diagram “P” on page 16. Connect wires for AL1, AL2, AL3 & AL4.

Option 3018-M

Four Alarm Setpoints (Electro-Mechanical Relays)

This option is similar to option 3017-M, but contains four relays (see option 3017-M). For connection wiring details, see diagram “M” on page 16. Connect wires for AL1, AL2, AL3 & AL4.

Option 3025

Keypad Lock Option

The keypad lock option is used to prevent un-authorized access to the programming menu. When this option is ordered, a new sub-menu called "CODE" appears at the end of the programming sequence. See programming page 8.

Three levels of keypad lockout are available:

Level 0 - Full access to programming menu.

Level 1 - User only has access to alarm setpoint values.

Level 2 - Total programming menu lockout.

If this option is ordered, the factory default is "Lev 0".

If the keypad has been locked with either level 1 or 2, then the word "PASS" will appear on the display if the user attempts to enter programming mode. Pressing the menu key will return the instrument to normal display mode. However, if the user wishes to enter the programming menu, then when the word "PASS" appears, press in succession, 1 second apart, all four keys from right to left.



Declaration of Conformity

Diagram "P"

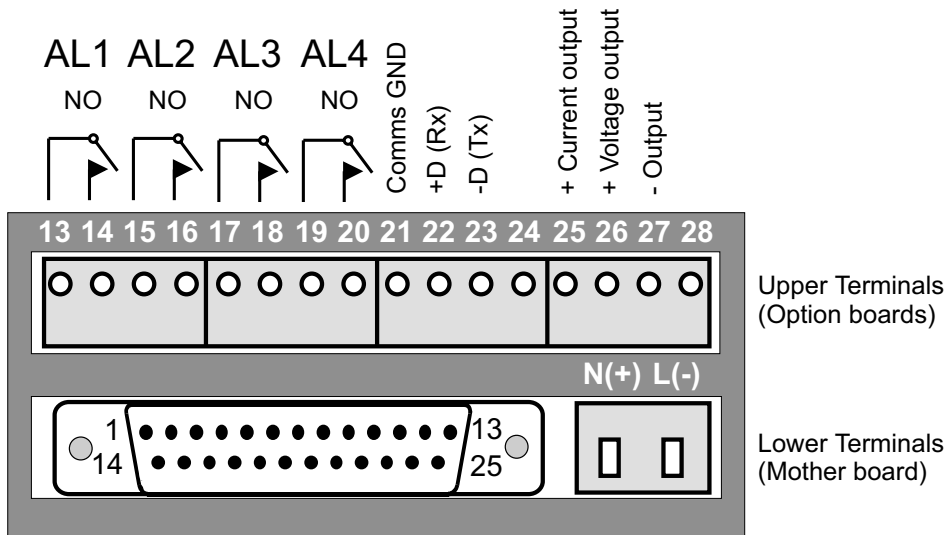

Universal programmable BCD / Gray Code / Binary input indicator

Manufacturer : DPM

Type : 5002

Options : 3000 to 3026

Corresponds to the requirements of the following EC directives:

- EMC directive : 89/336/EEC
- Low voltage directive : 73/23/EEC
- The applicable harmonised standards are : EN 50081-1
- : EN 50082-1
- : EN 61010

Diagram "M"

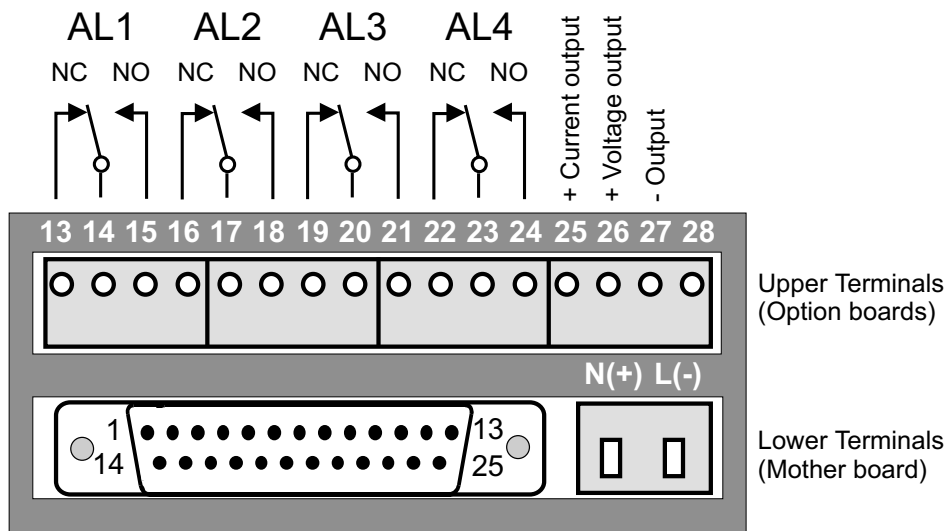

Guarantee

This product is guaranteed against faulty workmanship or defective material, for a period of 3 (three) years from date of delivery.

The manufacturer undertakes to replace without charge all defective equipment which is returned to it (transportation costs prepaid) during the period of guarantee, provided there is no evidence that the equipment has been abused or mishandled in any way.

The manufacturer reserves the right to alter any specification without notice.